

**ALPINE ELECTRONICS MARKETING,
INC.**

1-1-8 Nishi Gotanda, Shinagawa-ku,
Tokyo 141-0031, Japan
Phone 03-5496-8231

ALPINE ELECTRONICS GmbH

Frankfurter Ring 117,
80807 München, Germany
Phone 089-32 42 640

**ALPINE ELECTRONICS OF AMERICA,
INC.**

19145 Gramercy Place, Torrance,
California 90501, U.S.A.
Phone 1-800-ALPINE-1 (1-800-257-4631)

ALPINE ELECTRONICS OF U.K. LTD.

Alpine House
Fletchamstead Highway, Coventry CV4
9TW, U.K.
Phone 0870-33 33 763

**ALPINE ELECTRONICS OF CANADA,
INC.**

7300 Warden Ave., Suite 203,
Markham, Ontario L3R 9Z6, Canada
Phone 1-800-ALPINE-1 (1-800-257-4631)

ALPINE ELECTRONICS FRANCE S.A.R.L.

(RCS PONTOISE B 338 101 280)
98, Rue de la Belle Etoile, Z.I. Paris Nord II,
B.P. 50016, 95945 Roissy Charles de Gaulle
Cedex, France
Phone 01-48638989

**ALPINE ELECTRONICS OF ASIA PACIFIC
CO, LTD.**

555 Rasa Tower 1, Unit 2601-2602, 26th
Floor, Phaholyothin Rd.
Chatuchak, Bangkok, Thailand 10900
Phone: 662 (937) 0505
Fax: 662 (937) 0569

ALPINE ITALIA S.p.A.

Viale C. Colombo 8, 20090 Trezzano
Sul Naviglio (MI), Italy
Phone 02-484781

**ALPINE ELECTRONICS OF AUSTRALIA
PTY. LTD.**

6-8 Fiveways Boulevard Keysborough,
Victoria 3173, Australia
Phone 03-9769-0000

ALPINE ELECTRONICS DE ESPAÑA, S.A.

Portal de Gamarra 36, Pabellón 32
01013 Vitoria (Alava)-APDO 133, Spain
Phone 945-283588



FOR CAR USE ONLY



Advanced Video Interface for iPod.

KCE-425i



OWNER'S MANUAL

Please read before using this equipment

Package Contents:
KCE-425i
iPod Cable (2m)
Power Cable (0.5m)
IR Remote Eye with 3.5mm Jack (4.5m)
IR Remote Control
Remote in lead for ALPINE monitors
Owner's Manual

Support and manuals in other languages available at:
www.alpine-europe.com

Connection Diagram

Note: Make sure to set the selected AUX input of your Alpine overhead monitor to 'EXT DVD'

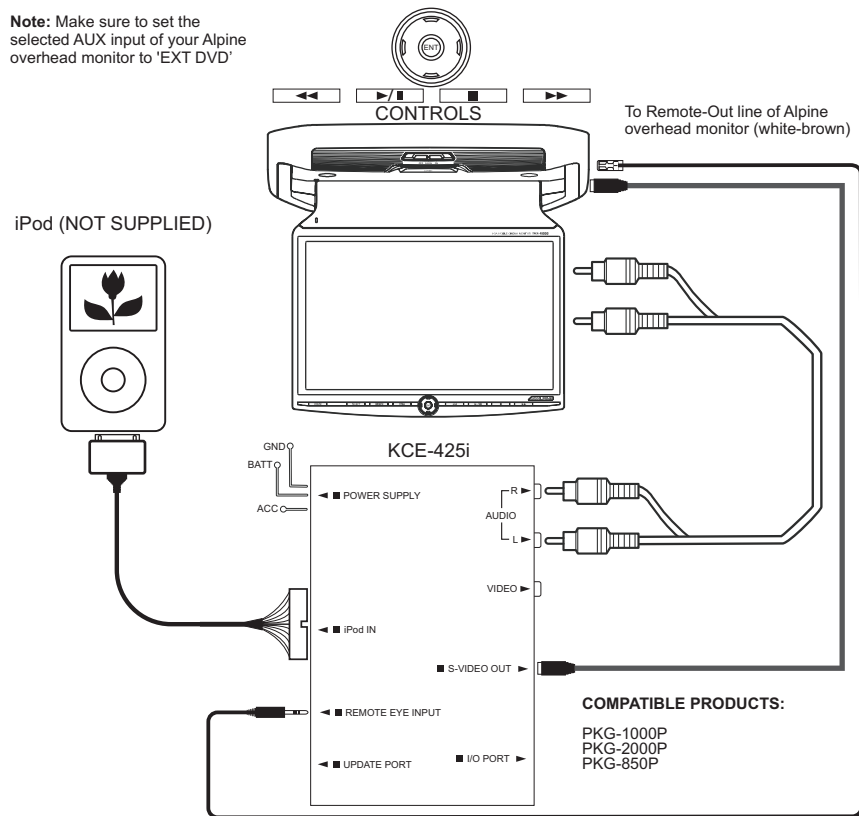

Precautions	4
Introduction	5
Remote	6
On Screen Navigation	8
My Jukebox	9
Viewing Photos on Screen	10
Switching OSD Languages	12
Tips and Trouble Shooting	13
Switching Video Formats	14
Technical Specifications	17
iPod Compatibility	18
Using RUE-4191	21
Installation	22



DO NOT WATCH VIDEO WHILE DRIVING.

Watching the video may distract the driver from looking ahead of the vehicle and cause an accident.

DO NOT OPERATE ANY FUNCTION THAT TAKES YOUR ATTENTION AWAY FROM SAFELY DRIVING YOUR VEHICLE.

Any function that requires your prolonged attention should only be performed after coming to a complete stop. Always stop the vehicle in a safe location before performing these functions. Failure to do so may result in an accident.

MINIMIZE DISPLAY VIEWING WHILE DRIVING.

Viewing the display may distract the driver from looking ahead of the vehicle and cause an accident.

DO NOT DISASSEMBLE OR ALTER.

Doing so may result in an accident, fire or electric shock.

USE ONLY IN CARS WITH A 12 VOLT NEGATIVE GROUND.

(Check with your dealer if you are not sure.) Failure to do so may result in fire, etc.

Operating Instructions

KEEP SMALL OBJECTS SUCH AS BOLTS OR SCREWS OUT OF THE REACH OF CHILDREN.

Swallowing them may result in serious injury. If swallowed, consult a physician immediately.

USE THE CORRECT AMPERE RATING WHEN REPLACING FUSES.

Failure to do so may result in fire or electric shock.

DO NOT BLOCK VENTS OR RADIATOR PANELS.

Doing so may cause heat to build up inside and may result in fire.

USE THIS PRODUCT FOR MOBILE 12V APPLICATIONS.

Use for other than its designed application may result in fire, electric shock or other injury.



HALT USE IMMEDIATELY IF A PROBLEM APPEARS.

Failure to do so may cause personal injury or damage to the product. Return it to your authorized Alpine dealer or the nearest Alpine Service Centre for repairing.

Connection Diagram

Note: Make sure to set the selected AUX input of your Alpine touchscreen to 'EXT DVD'

TOUCH MONITOR CONTROLS*



*Please note that only basic controls are available on some models

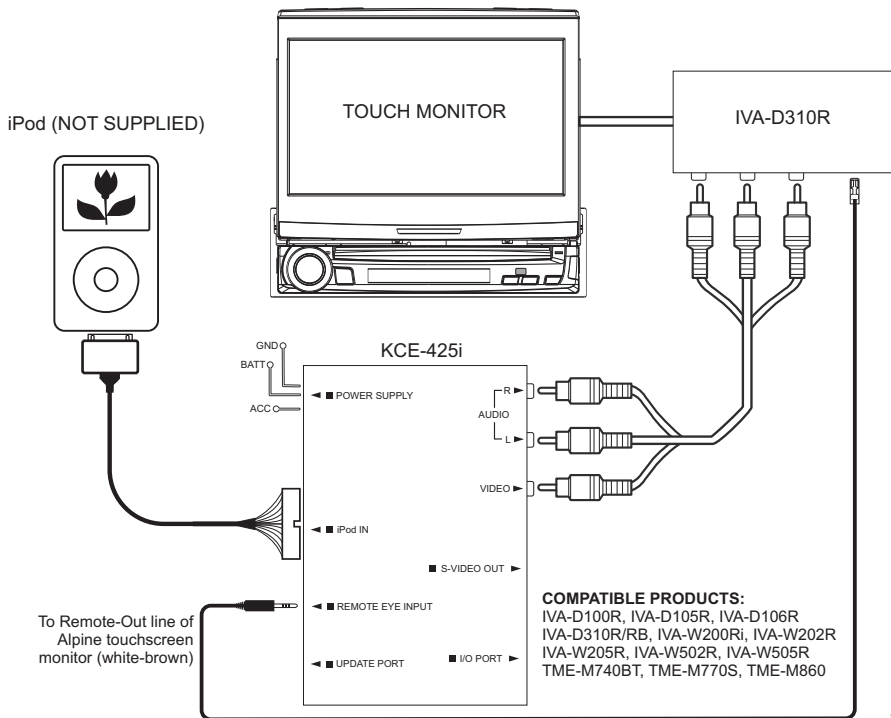

Connection Diagram

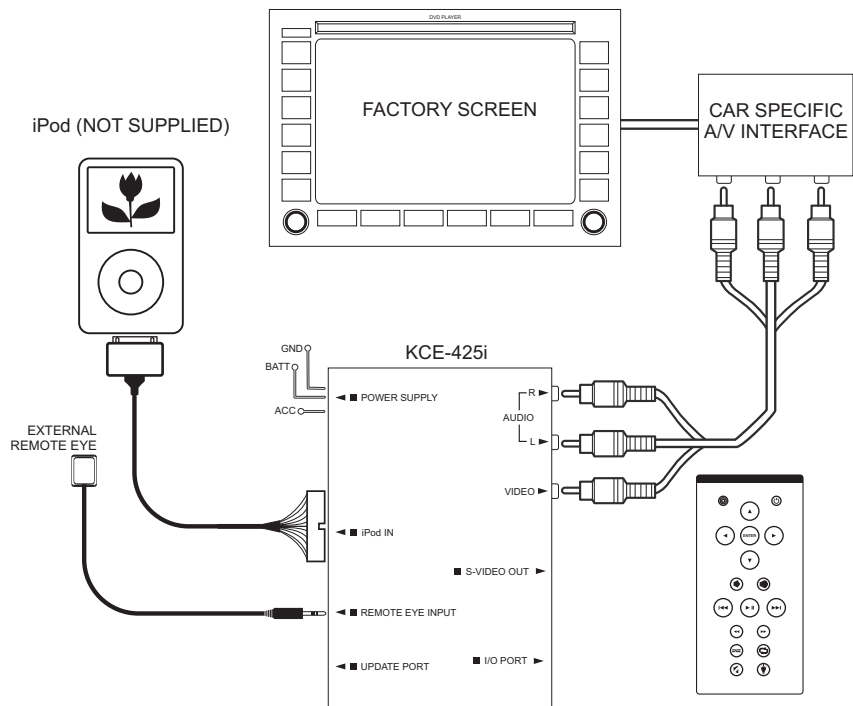

With an available A/V input in your mobile multimedia system, this product allows use of your iPod to:

- Play your music
- Playback video
- Display pictures in a slideshow

You will have full control of your iPod via:

- Infrared Remote Control
- Alpine touch screen or roof monitor
- Via the iPod itself

You can use the KCE-425i as source in:

- An Alpine mobile multimedia system with any touch screen monitor
- An Alpine Rear-Seat entertainment system with roof or touch screen monitor
- Any Rear-Seat entertainment system with A/V input
- Any Factory system with a matching A/V interface

This versatile add-on solution lets you connect your iPod to a monitor in your car and enjoy all your iPod entertainment, including movies! The black-box KCE-425i not only brings your current system up-to-date for watching movies, it gives you a sophisticated user interface that works similar to iPod, with same convenience and ease of use. Listen to your iPod music on your car system, watch iPod videos, even listen to audio books and podcasts, too. It's the perfect solution for bringing the iPod into an existing mobile multimedia system.

Remote Control Functions

The Alpine KCE-425i lets you enjoy your iPod music through your in car multi media system as well as playing your iPod movies through your in car screen.

You can either select your Music or Videos directly from your iPod (**iPod Mode**) when not wishing to use the remote control, or switch to **On-Screen Navigation Mode** to view, navigate and select your Music or Videos using Alpine KCE-425i's sleek **On-Screen Navigation**.

To switch between On-Screen Navigation and iPod Mode, use the Mode button on the remote control. In iPod Mode, Videos and Photos will be send to your screen, provided the TV Output on the iPod is enabled.

Refer to the remote control illustration for more information about the Alpine KCE-425i's Remote Control.



HAVE THE WIRING AND INSTALLATION DONE BY EXPERTS.

The wiring and installation of this unit requires special technical skill and experience. To ensure safety, always contact the dealer where you purchased this product to have the work done.

USE SPECIFIED ACCESSORY PARTS AND INSTALL THEM SECURELY.

Be sure to use only the specified accessory parts. Use of other than designated parts may damage this unit internally or may not securely install the unit in place. This may cause parts to become loose resulting in hazards or product failure.

ARRANGE THE WIRING SO IT IS NOT CRIMPED OR PINCHED BY A SHARP METAL EDGE.

Route the cables and wiring away from moving parts (like the seat rails) or sharp or pointed edges. This will prevent crimping and damage to the wiring. If wiring passes through a hole in metal, use a rubber grommet to prevent the wire's insulation from being cut by the metal edge of the hole.

DO NOT INSTALL IN LOCATIONS WITH HIGH MOISTURE OR DUST.

Avoid installing the unit in locations with high incidence of moisture or dust. Moisture or dust that penetrates into this unit may result in product failure.

Installation and Connections

Precautions

- Be sure to disconnect the cable from the (-) battery post before installing your IVA-D106R. This will reduce any chance of damage to the unit in case of a short-circuit.
- Be sure to connect the colour coded leads according to the diagram. Incorrect connections may cause the unit to malfunction or damage to the vehicle's electrical system.
- When making connections to the vehicle's electrical system, be aware of the factory installed components (e.g. on-board computer). Do not tap into these leads to provide power for this unit. When connecting the IVA-D106R to the fuse box, make sure the fuse for the intended circuit of the IVA-D106R has the appropriate amperage. Failure to do so may result in damage to the unit and/or the vehicle. When in doubt, consult your ALPINE dealer.



MAKE THE CORRECT CONNECTIONS

Failure to make the proper connections may result in fire or product damage.

USE ONLY IN CARS WITH A 12 VOLT NEGATIVE GROUND.

(Check with your dealer if you are not sure.) Failure to do so may result in fire, etc.

BEFORE WIRING, DISCONNECT THE CABLE FROM THE NEGATIVE BATTERY TERMINAL.

Failure to do so may result in electric shock or injury due to electrical shorts.

DO NOT ALLOW CABLES TO BECOME ENTANGLED IN SURROUNDING OBJECTS.

Arrange wiring and cables in compliance with the manual to prevent obstructions when driving. Cables or wiring that obstruct or hang up on places such as the steering wheel, shift lever, brake pedals, etc. can be extremely hazardous.

DO NOT SPLICE INTO ELECTRICAL CABLES.

Never cut away cable insulation to supply power to other equipment. Doing so will exceed the current carrying capacity of the wire and result in fire or electric shock.

Installation and Connections

DO NOT DAMAGE PIPE OR WIRING WHEN DRILLING HOLES.

When drilling holes in the chassis for installation, take precautions so as not to contact, damage or obstruct pipes, fuel lines, tanks or electrical wiring. Failure to take such precautions may result in fire.

DO NOT USE BOLTS OR NUTS IN THE BRAKE OR STEERING SYSTEMS TO MAKE GROUND CONNECTIONS.

Bolts or nuts used for the brake or steering systems (or any other safety-related system), or tanks should **NEVER** be used for installations or ground connections. Using such parts could disable control of the vehicle and cause fire etc.

KEEP SMALL OBJECTS SUCH AS BOLTS OR SCREWS OUT OF THE REACH OF CHILDREN.

Swallowing them may result in serious injury. If swallowed, consult a physician immediately.

DO NOT INSTALL IN LOCATIONS WHICH MIGHT HINDER VEHICLE OPERATION, SUCH AS THE STEERING WHEEL OR SHIFT LEVER.



Doing so may obstruct forward vision or hamper movement etc. and results in serious accident.

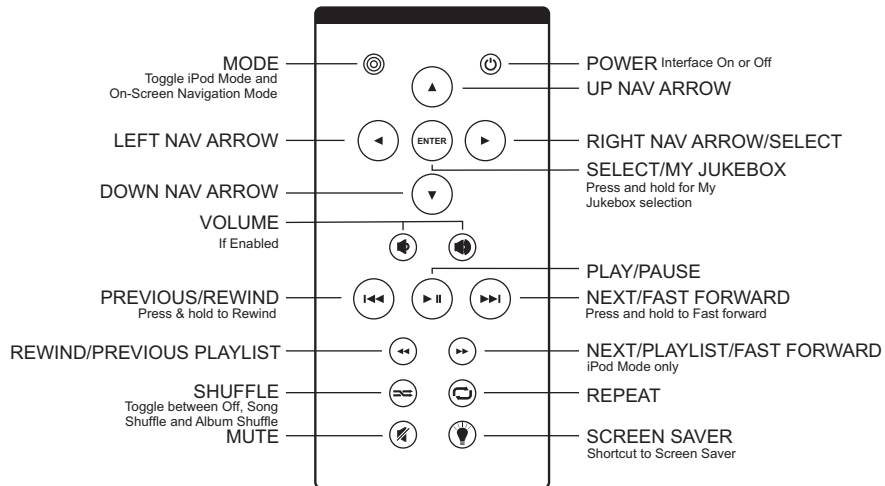

Remote Control Functions



To Select Music or Video Using On Screen Navigation

Use **On-Screen Navigation Mode** to control and display your iPod's Music and Videos, including Playlists, TV Shows, Rentals, Movies, Albums, Artists, Songs, Genres, Podcasts, etc.

1. Select **Music** or **Videos** from the Main Menu Screen
2. Select the category of Music or Video you would like to view: **Playlists, Movies, TV Shows, Artists, Albums, Songs, Podcasts**, etc.
3. Scroll up or down to select the particular Song or Video you would like to play. Then with the Song highlighted, press the **Enter Button**  or hit the **Right Nav Arrow Button** .

To return to the main menu during Video playback, push the **Enter Button**  on the remote control. To return to the main menu from Audio playback keep pressing the **Left Nav Arrow Button**  on the remote control until you return to the main menu.

From the Main Menu Screen, you can also go immediately to your iPod's Playlists and choose one to listen to. You can even choose **Shuffle Songs** to play songs randomly from your library.

Any time a track is playing from your iPod using the Alpine KCE-425i, the current track info is displayed at the top of your screen with Album Art (if available). The Alpine KCE-425i also displays a track countdown timer, the track progress bar, the name of your iPod, as well as Album and Playlist information (if applicable).

Alpine RUE-4191 Universal Remote Controller

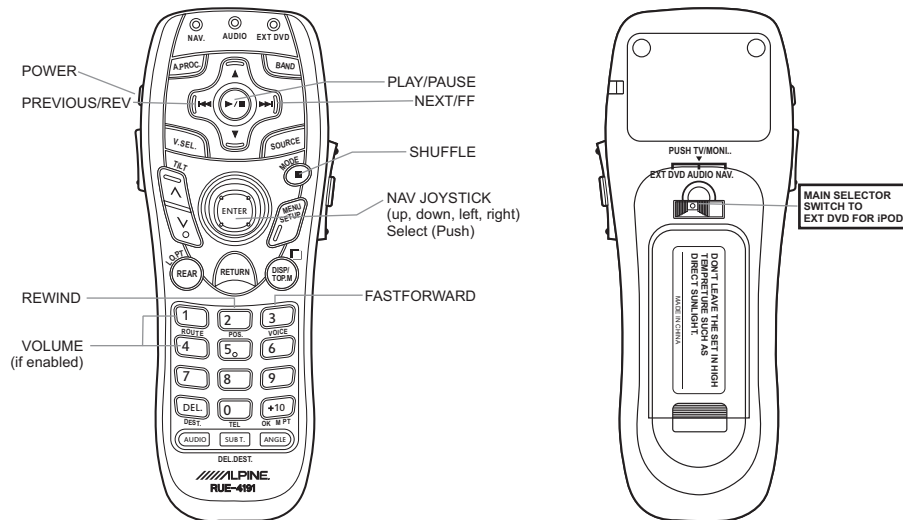

iPod Models Supported

VIDEO COMPATIBILITY:

All iPods with Video capability

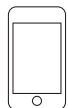

iPod touch
2nd generation
8GB 16GB 32GB



iPod nano
4th generation (video)
8GB 16GB



iPod classic
120GB



iPod touch
1st generation
8GB 16GB 32GB



iPod nano
3rd generation (video)
4GB 8GB



iPod classic
80GB 160GB



iPod
5th generation (video)
30GB 60GB 80GB

Using the My Jukebox Feature

The Alpine KCE-425i gives you the option of creating your own Playlists from your iPod directly on your in car screen. You can select these on-the-fly Playlists using the **My Jukebox** feature on the Main Menu Screen. Here's how:

1. Select any Song from a playlist, artist or album. Then, press and hold the **Enter Button**  on your Remote Control .
2. When the Highlight Bar blinks, the song selection has been copied to your My Jukebox Playlist on the Main Menu Screen.
3. After you have selected as many items as you want for your My Jukebox Playlist, you may navigate back to the Main Menu Screen to play selections from My Jukebox.
4. To clear your My Jukebox Playlist, simply select **Clear List** and hold.

NOTE: My Jukebox will not save a Playlist after an iPod is disconnected or if the Alpine KCE-425i is powered off.

Viewing Photos on Screen with the Alpine KCE-425i

To view pictures from your photo-compatible iPod, follow these easy steps:

1. Connect your iPod. Switch the KCE-425i to iPod Mode (**MODE Button**, top left on the remote control)

2. Navigate, select and play a Slideshow from your iPod using the KCE-425i remote control or the iPod controls.

NOTE: Be sure to select **On** under **TV Out** within Slideshow Settings on your iPod menu. You can use the Remote Control's Nav Arrow Buttons to make your selections.

3. Once you selected a slideshow from your library, start it with the Play button

NOTE: Enter/ Select will display the pictures on the iPod only

4. Control functions such as Play/Pause, Next Slide, Previous Slide from the comfort of your seat with the Alpine KCE-425i Remote Control. Refer to the Remote illustration to learn how to direct your photo slide shows using the Alpine KCE-425i Remote Control.

NOTE: Unfortunately, the iPod nano (1st and 2nd Generation) and iPod Touch do not currently support external playback of its **internal photos**. However, all music functions, including On Screen Navigation, work great with all of them.

If you have questions or need help setting up your iPod for Photos and Slide shows, please visit Apple Support at

www.apple.com/support/ipod.

iPod Models Supported

PICTURE COMPATIBILITY:

All iPods with Colour Display



iPod nano
4th generation (video)
8GB 16GB



iPod nano
3rd generation (video)
4GB 8GB



iPod classic
80GB 160GB



iPod
5th generation (video)
30GB 60GB 80GB



iPod classic
120GB

iPod Models Supported

Controlling Your Photos in iPod Mode

MUSIC COMPATIBILITY:

All Dockable iPods (excluding 3G & 4G iPod)

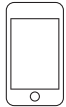

iPod touch
2nd generation
8GB 16GB 32GB



iPod classic
80GB 160GB



iPod nano
4th generation (video)
8GB 16GB



iPod
5th generation (video)
30GB 60GB 80GB



iPod classic
120GB



iPod nano
1st generation
1GB 2GB 4GB

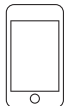

iPod touch
1st generation
8GB 16GB 32GB



iPod nano
2nd generation (aluminum)
2GB 4GB 8GB



iPod nano
3rd generation (video)
4GB 8GB

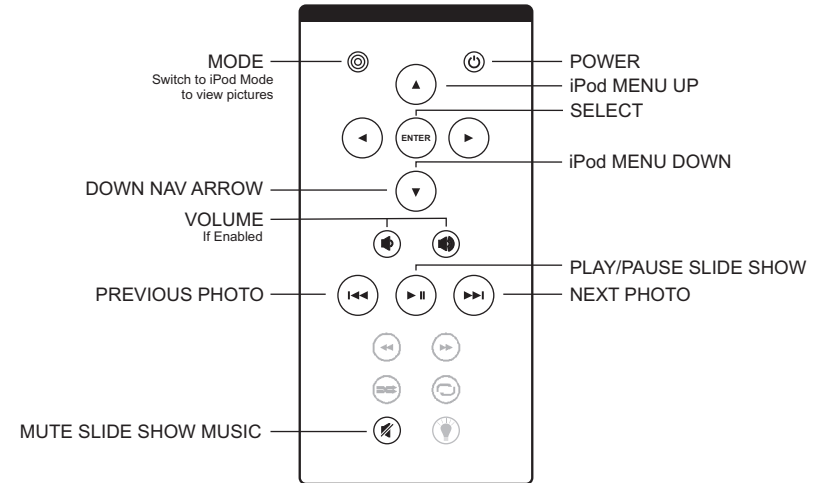

Language

The Alpine KCE-425i has 9 different languages. Select yours from the Alpine KCE-425i Settings/Languages.

Available Languages:

English

Spanish

French

German

Italian

Dutch

Japanese

Russian

Swedish

Inputs/Outputs

Left/Right Audio: analog audio output

Video: composite video output

S-Video: separated analog video output

Power Input: 11-15volts/dc

USB-A: standard universal serial bus, USB 2.0
(only to be used for firmware updates)

Remote Control

Battery: 3V, type CR2032 or equivalent

Television Video Format

NTSC/PAL (software switchable)

I've selected a photo slideshow to play on my screen, but it's only playing on my iPod screen.

On your iPod, check to see that your **TV Out** setting under Video/Slideshow Settings is set to either **Ask** or **On**. Your Video or Slideshow will not play on your screen unless you select **TV On** when prompted by your iPod in the **Ask** setting, or you have selected On under **TV Out** in Video Settings. Your iPod arrives in the **Ask** setting, so you will have to select **TV On** each time you start up a Video or Photo Slideshow unless you change your iPod Settings. Remember, iPod nano does not support external photo slideshows. For more information see the **NOTE** on [page 10]

The Alpine KCE-425i sometimes seems to have a lag time before it displays my iPod's content like album art or song information. Why?

The response delay time, if any, is usually the Alpine KCE-425i waiting for information from the iPod. Hard-drive based iPods like the 5G iPod with video take longer than flash based iPods like the iPod nano. How long it takes depends on how much content is on the iPod and what information is being requested. For instance, when you've selected 'Now Playing' on the Alpine KCE-425i that displays "large" Album Art 200 x 200 pixels, (if available), it can take up to 20 seconds for the iPod to access that art work. See **Things to Understand About iPod Album Art** [page 13] for more information.

Things to Understand About iPod Album Art*

The maximum size of Album Art available is 200 x 200 pixels from iPods with Video. For the iPod nano, the maximum Album Art size is 100 x 100 pixels. It can take several seconds to load artwork from your iPod. While the larger 200 x 200 pixel artwork is loading, the Alpine KCE-425i will display smaller Album Art.

NOTE: You will see a **Please Wait** message if you attempt to use the remote while your iPod is delivering Album Art to the Alpine KCE-425i.

If your current selection does not have any Album Art, or if the Album Art is unavailable, the Alpine KCE-425i will display the icon below instead of Album Art.

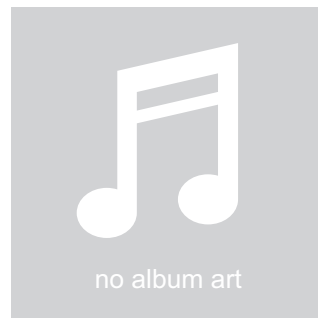

*(if available)

Switching Between NTSC and PAL

The Alpine KCE-425i default broadcast format is NTSC. However, it is PAL compatible too. If you have a screen that is configured for PAL and your iPod's video format is set for PAL, simply select the PAL setting in Alpine KCE-425i **Settings**.

All Alpine screens are native NTSC screens, therefore we recommend that you set your iPod and KCE-425i to NTSC video format for best picture quality.

To toggle between NTSC and PAL settings, follow the steps below:

NTSC to PAL

1. Be sure you are on the Main Menu Screen

NOTE: Your iPod must be removed from the Alpine KCE-425i before attempting to change formats.

2. Press the **Left Arrow Button** (◀) once, then the **Down Arrow Button** (▼) once, Repeat.

This will switch your video output from NTSC to PAL.

PAL to NTSC

1. Be sure you are on the Main Menu Screen

NOTE: Your iPod must be removed from the Alpine KCE-425i before attempting to change formats.

2. Press the **Left Arrow Button** (◀) once, then the **Up Arrow Button** (▲) once. Repeat.

This will switch your video output from PAL to NTSC.

My Alpine KCE-425i isn't working, what's wrong?

First, be sure that your Alpine KCE-425i is powered on. Next, make sure that you are in the desired mode - **On-Screen Navigation Mode** or **iPod Mode**. To change modes, simply push the **Mode Button** on your Remote Control. See Remote Control Functions [page 07]

Sometimes NEXT ►►I seems not to work?

While Album art is loaded, the remote commands are not executed immediately. One command will be stored and executed when the full album art is loaded. In the normal menu screen, this blackout time usually starts 3 seconds after playback of a song begins and can take 7 seconds, depending on the iPod model. In 'Now Playing' mode the blackout starts immediately and takes up to 15 seconds. Please refer to (page16)

My audio is distorted, how can I improve it?

Files on your iPod can come from many different sources (i.e. iTunes store, ripping your own CDs, Podcasts etc.). The audio levels on these differ widely. The fixed volume setting in the set-up menu leaves usually enough headroom to avoid distortion by clipping. If this is not enough, enable the volume control (SETTINGS-AUDIO SETTINGS-VARIABLE) and lower the volume as needed.